

Diagnostic solutions **CAR**

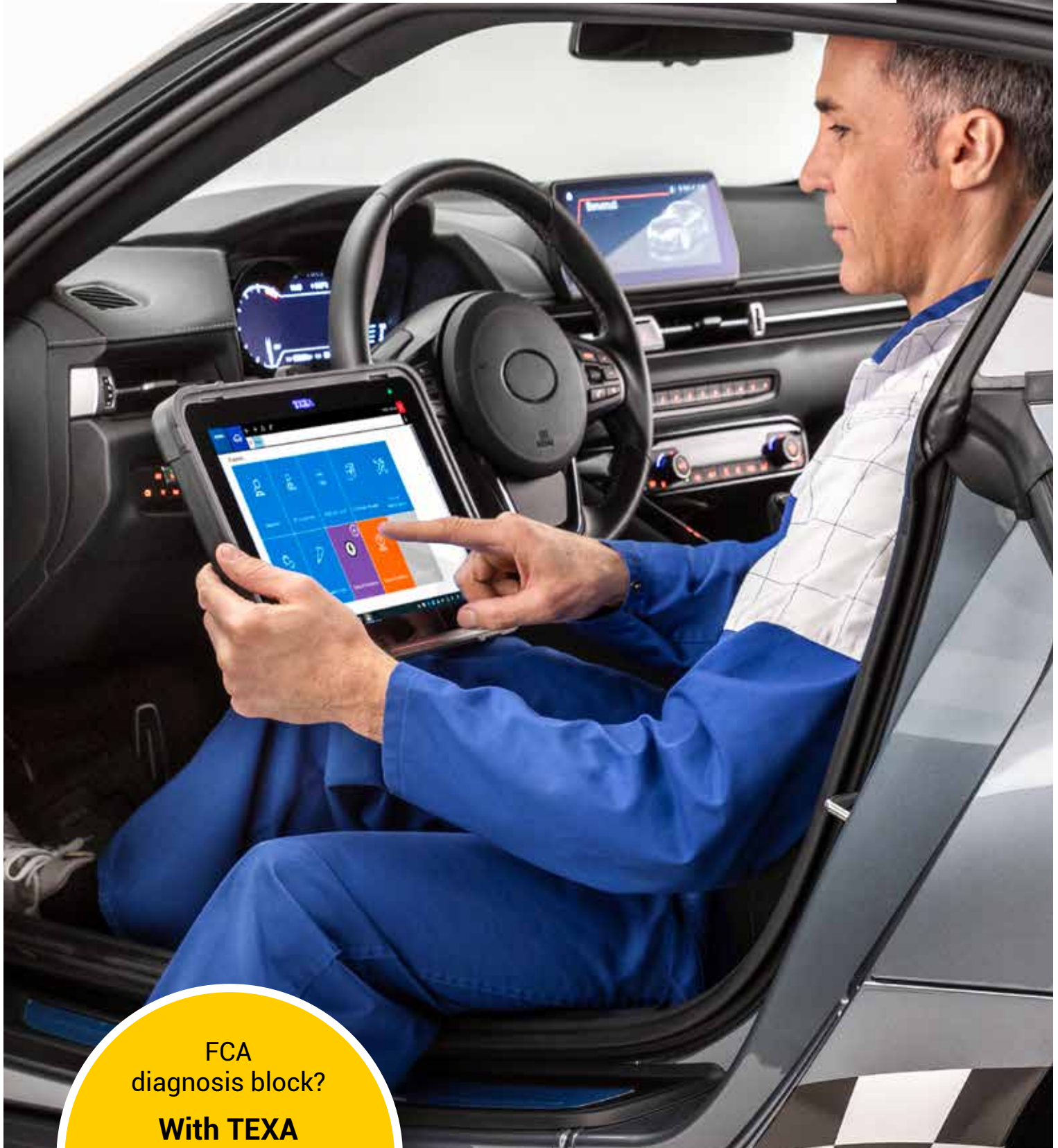

FCA
diagnosis block?

With TEXA
the FCA authenticated
diagnostic solution
that protects
the warranty

TEXA

GLOBAL SPECIALISTS IN DIAGNOSTICS

TEXA has always been a reference point in the world of automotive equipment, and this leading position has been consolidated through the design and manufacture of innovative tools for electronic autodiagnosis, electrical diagnosis, exhaust gas analysis and air conditioning system service stations, for use on cars, trucks, motorcycles, agricultural vehicles and marine applications. Over the years, TEXA has built up an extensive global network of over 700 distributors in over 100 countries.

A complete and modular offer

TEXA offers the technician total assistance during all phases of a repair, from the analysis of fault symptoms to the identification of the right spare part. TEXA boasts an unrivalled offering of tools and services designed to satisfy all possible needs. From dedicated workshop tools to operating software, specialist training and customer services.

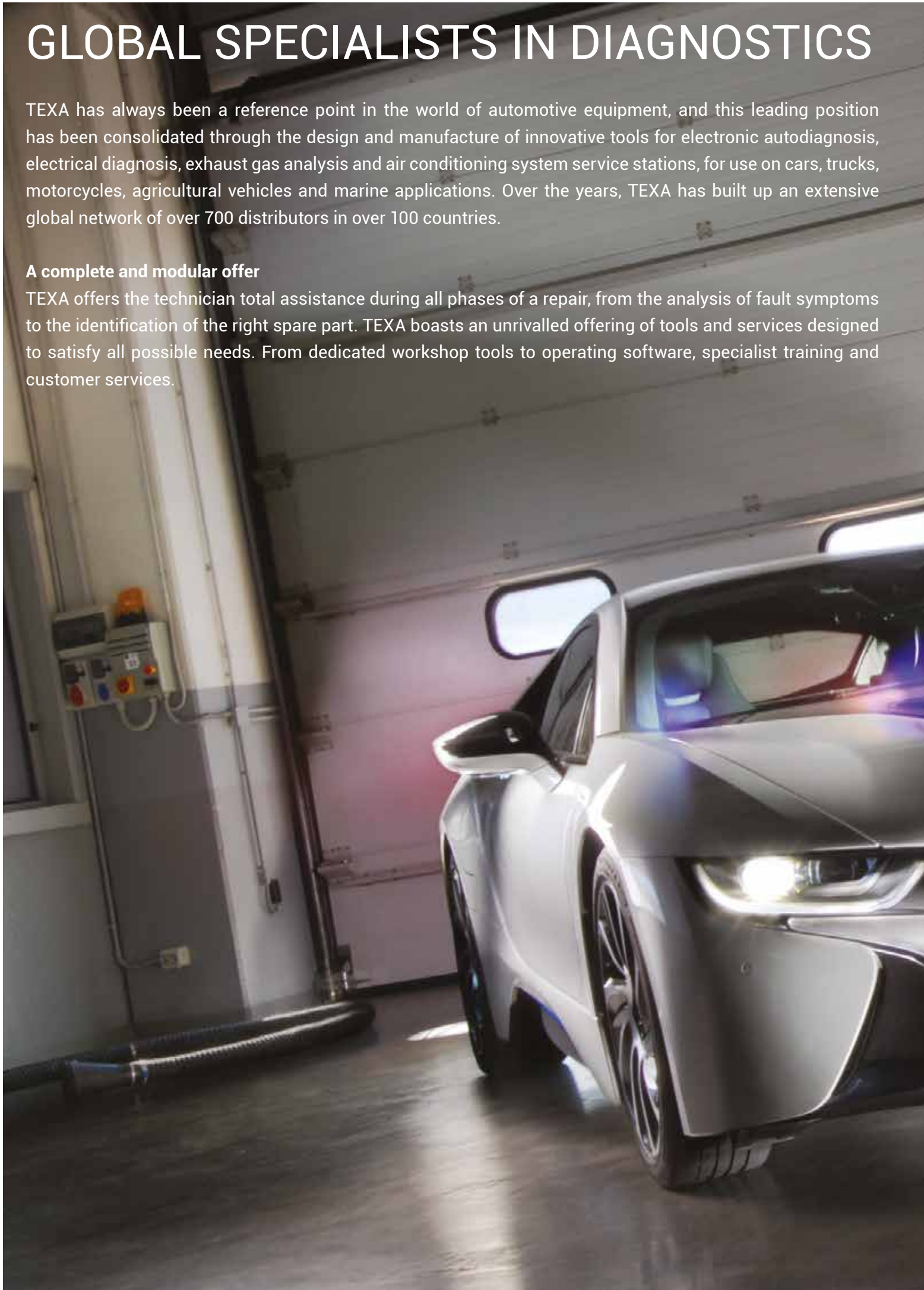

WITH TEXA THE FCA AUTHENTICATED SOLUTION

As is known, from 2017 the FCA Group introduced protective measures that inhibited the possibility for independent workshops to intervene on its most recent models. A decision that TEXA contested immediately, both directly and through the trade associations it is a member of, since it is against the European legislation on repairs. Unlike others, we did not follow the path towards solutions that get round the safety protection exposing mechanics to the severe liability risks towards the manufacturer and towards drivers. Instead, with the reliability and responsibility that a large company must always guarantee its customers, we worked with the European and national organisations to establish the best collaboration possible with the FCA Group in order to solve the problem. Therefore, we are pleased to announce that through TEXA's tools, it's now possible to work on the latest generation of vehicles produced by the Turin Group in complete safety and legality.



IDC5 Software

Diagnosis without frontiers

IDC5 is the latest generation of TEXA's renowned operating system and another step forward to assist technicians. Thanks to major improvements in code the new system is faster than ever and guarantees virtually instant communication with a vehicle's control units.

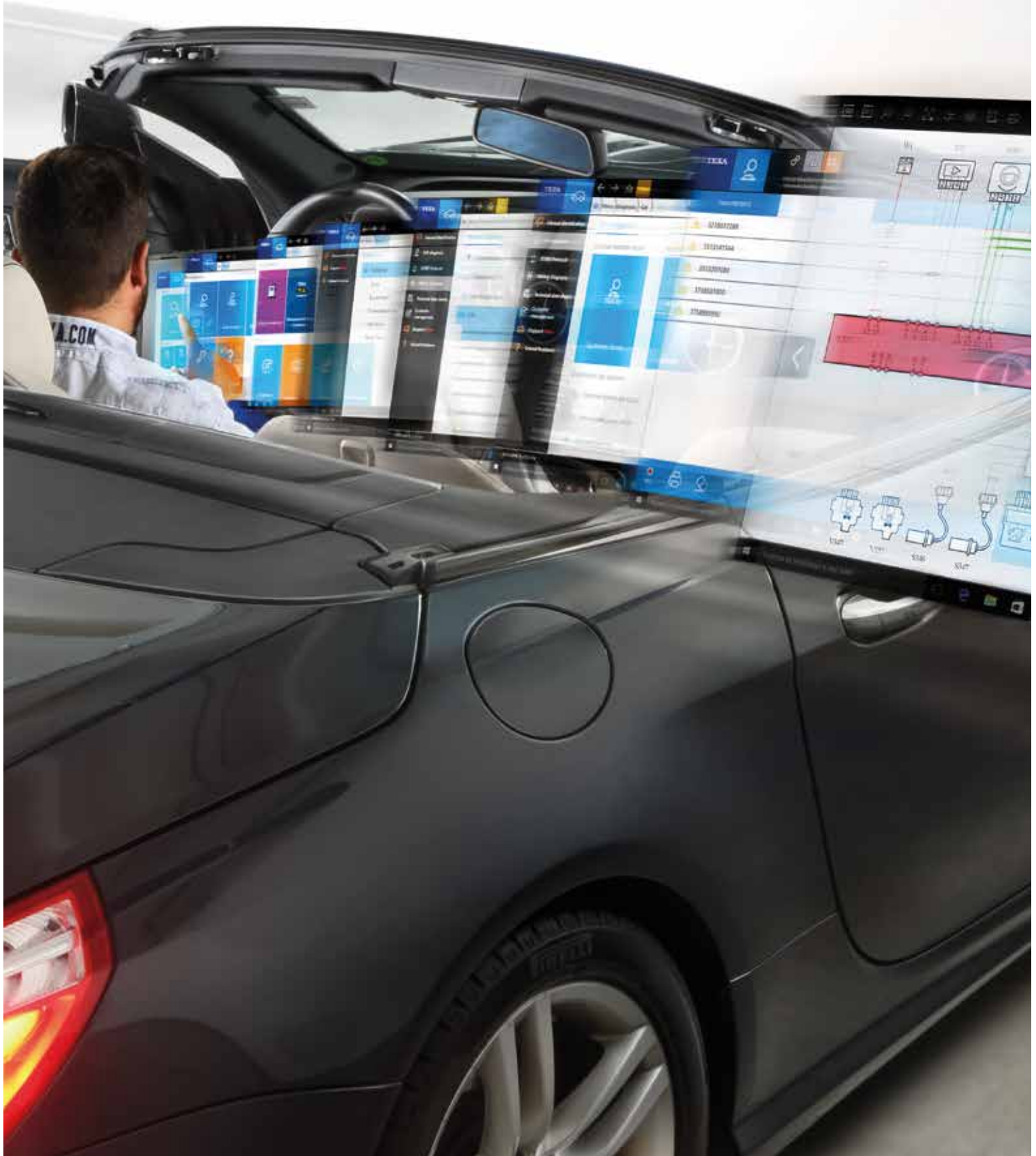

An even more intuitive software interface

The graphic interface of IDC5 is designed to resemble the latest consumer applications, **simplifying and making the various steps** in maintenance and repair procedures more intuitive. On top of this, all diagnostic pages have been redesigned to give a **fuller view of the most relevant information**.

Another new function allows you view and manage vehicle parameters. These can be displayed in graphic form and can be filtered using text searches or by selecting those specifically required.

Even the **downloading of updates is faster** in the new software. IDC5 is designed to guarantee compatibility with the new ISO 13400 standard, also known as the Ethernet/DoIP communication protocol, using AXONE NEMO 2 or a Windows PC.



TEXA APP: the new way to customise your diagnostic tool

TEXA has introduced a completely new concept of diagnostic support in the form of the **TEXA APP virtual store**.

TEXA APP is the list of applications developed by TEXA that allow extending the software functions or coverage, for example, to simplify the technician's work.



DASHBOARD MODE

DASHBOARD is the innovative function that lets you view vehicle engineering parameters using extremely intuitive and attractive graphics that reproduce an industrial vehicle's dashboard, the mechanical components and operating logic of the selected system.



DUAL MODE

DUAL MODE is the innovative function that lets you connect and view parameters on two different interfaces simultaneously: for example, self-diagnosis can be performed on a component whilst the signal is studied with an oscilloscope.



IMPIANTI GPL-METANO

LPG - CNG SYSTEMS is the APP that allows you to diagnose the LPG - CNG systems installed on used vehicles (after-sales). This APP allows you to work on a large number of vehicles of different brands and models on which an LPG - CNG system was installed.



SUPERCAR

SUPERCAR is the TEXA diagnosis software dedicated to sports car and large engine luxury car makes such as Ferrari, Lamborghini, Maserati, Morgan, Pagani, Porsche, giving access to hundreds of different diagnostic combinations.



KEY/REMOTE CONTROL CODING

Through this APP you can quickly access the vehicle's self-diagnostic functions in order to code the keys, the remote controls, the immobiliser control units in case of malfunctions or if they must be replaced.

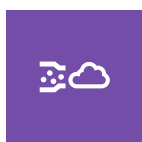

DPF REGENERATION

This App allows you to perform the particulate filter forced regeneration, in accordance with anti-pollution regulations. It is a very important operation in vehicles, especially in all those cases in which the spontaneous regeneration is not possible, i.e. in particular driving conditions or if the vehicle is mainly driven on urban roads.



ELECTRICAL VEHICLES

The APP ELECTRIC VEHICLES gives quick access to all the particular functions or activations that allow the analysis of problems and actions on the electric motor and on the vehicle's charging system.



TRANSPORTATION MODE PROGRAMMING

When the newly produced vehicles are delivered to the dealers, they have many functions that are deactivated, such as the radio, the central locking and other services. Through this APP you can quickly activate all the vehicle's functions by changing the status "Factory mode" to "Customer Mode".



DRIVING ASSIST SYSTEMS

Thanks to this APP, you can directly access the adaptation and programming functions linked to these control units, such as: calibrations and programming of the front/rear video cameras, necessary, for example, when replacing the windscreen or repairing the vehicle after a crash calibration of the front and rear parking sensors, in order to keep the system perfectly efficient, programming of the control units that control the lane keeping line.



TECHNICAL TRAINING

The dedicated TEXAEDU department offers a range of courses at various levels; from tool use introduction courses to more specific courses for professionals who require more specific system training. EDU APP is the application dedicated to technical training that always keeps you up to date on the latest news and available course dates and places.



SELF-DIAGNOSIS COMPONENT SHEETS

The "Self-Diagnosis Component Sheets" is the App designed by TEXA that provides the technician specific technical information regarding the most complex components within vehicle systems, giving an essential support for the diagnosis of the component itself.



AIRBAG VAG CODING

AIRBAG VAG CODING is TEXA s innovative App that allows you to calculate, quickly and precisely, the codes you need to code a new Airbag control unit of the VAG group. You just have to enter the control unit s code indicated is on its package in order to receive the 5 digit coding code you need for the installation.

and many more besides on:

<https://www.texa.com/software/texa-app>

PARTNER APP contains the applications created in collaboration between TEXA and operators who supply goods and services linked to the repair world, such as manufacturers or distributors of spare parts, specialised trade magazines, technical information services.

A world of technical and diagnostic contents to address the evolution of vehicles

A rapid evolution is characterising the automotive industry and, consequently, the world of diagnostics. For vehicle repairers, this results in the need to rely on tools that can allow them to operate on vehicles quickly and professionally and best satisfy their customers' requests.

For this reason, TEXA has introduced two major innovations: **TEXPACK CAR** and **TEX@INFO Guided Diagnosis**.

Besides the constant coverage update for cars and light commercial vehicles, TEXPACK CAR allows access to the information contained in the **Tech module*** by HaynesPro, with technical and maintenance data, repair manuals, technical illustrations and drawings, repair times, estimator and recalls.

On the other hand, the TEX@INFO Guided Diagnosis** service includes the activation of the **Electronics module** by HaynesPro, with a guided troubleshooting procedure through the identification, location and solution of the errors in the electrical system and components. It also includes the **Smart module**, with many solved problems and OEM technical service bulletins sorted by symptom, cause and solution.

The new technical contents are **perfectly integrated in the IDC5 diagnostic software** by TEXA and can be reached from "Technical Data and Checks" in the main menu, from the TGS3s vehicle scan if any DTCs are present, or from the diagnostic system via a direct link.



* Available for TEXPACK CAR contract subscribers with Plus or Premium license.

** Reserved for customers with active TEXPACK CAR.

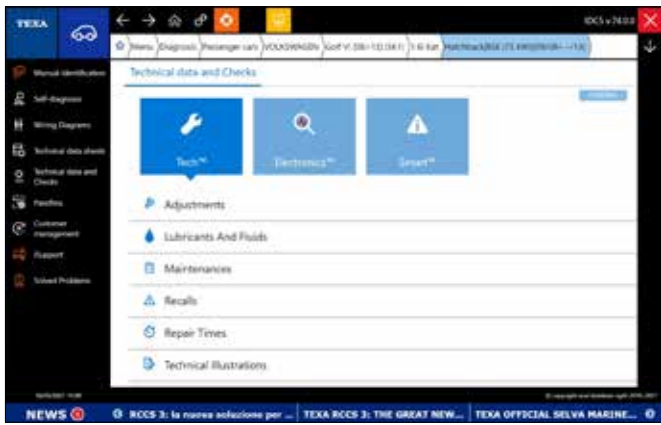

The new HaynesPro database, consisting of the Tech, Electronics and Smart modules, is easy to use and accessible from the Technical Data and Checks menu item, but also from the TGS3s vehicle scan and from the diagnostic system via a direct link.



After performing a global scan of the control units on board the vehicle, the Guided Diagnosis tab shows any detected errors and allows launching the troubleshooting procedure by clicking on the specific icon.

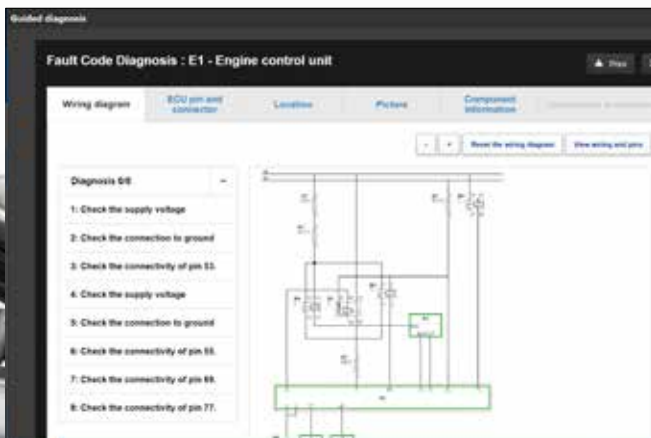

The guided diagnosis allows identifying, locating and solving any errors in the electrical system and components through a procedure integrated in the IDC5 diagnostic software.

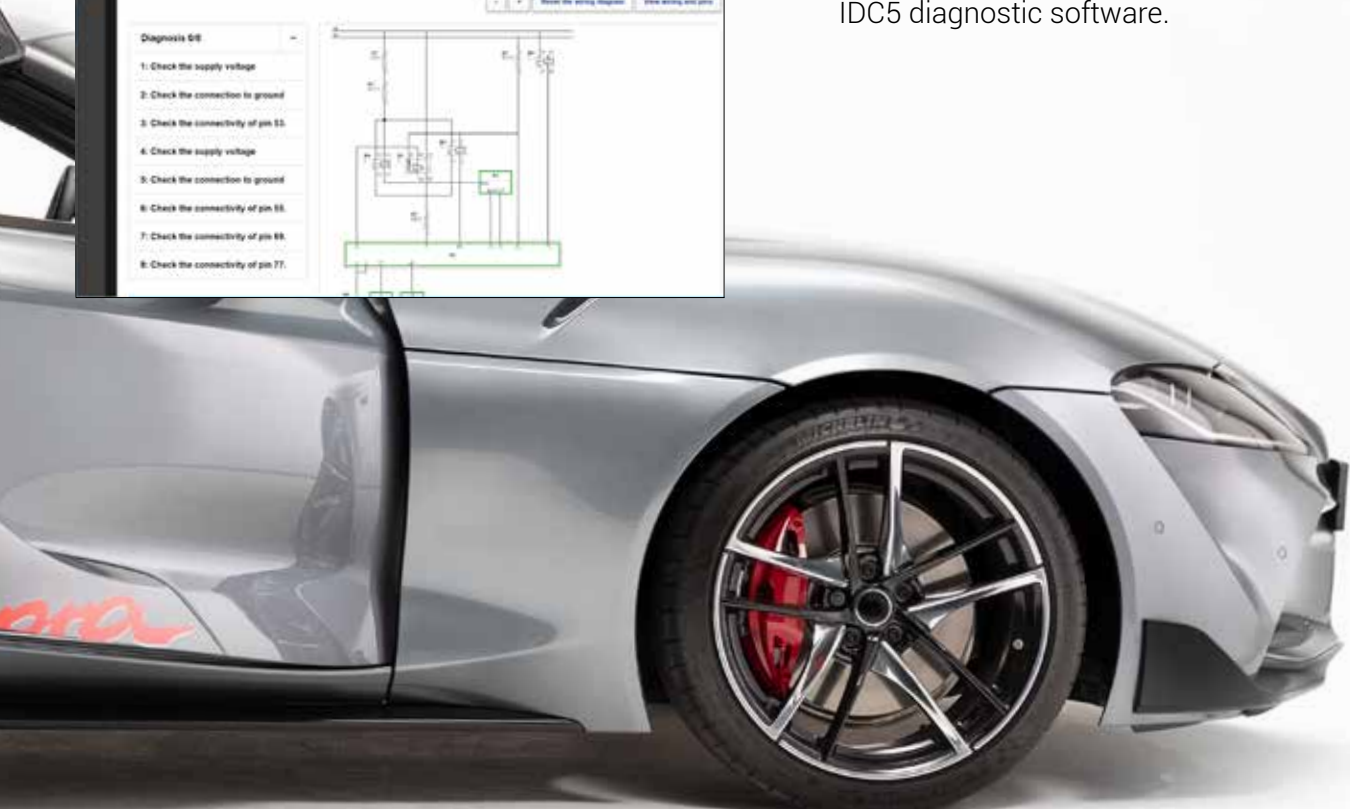



TEXA

VOVO TR
Electronics

PARAMETER	VALUE
Vehicle Mode	3238037288
Total mileage	3513141544
Outdoor temperature	3513207080
Wheelbase	3758581800
Supplementary pressure control valve	3758589992
Brake pedal position	
Rear axle steering angle signal request	
Rear axle steering output valve 1 PWM duty cycle request	

AXONE NEMO 2

A whole world of functions and services

IDC5 software provides a whole world of exclusive functions and services developed by TEXA's R&D department. These include:



SOLVED PROBLEMS powered by Google™

Implemented in **collaboration with Google**, this amazing function allows you to access TEXA databases easily, to search for repair procedures already encountered and registered by our international call centres. Vehicle repairers can access **thousands of practical troubleshooting cases**, tested on site by mechanics all over the world, **24/7**.

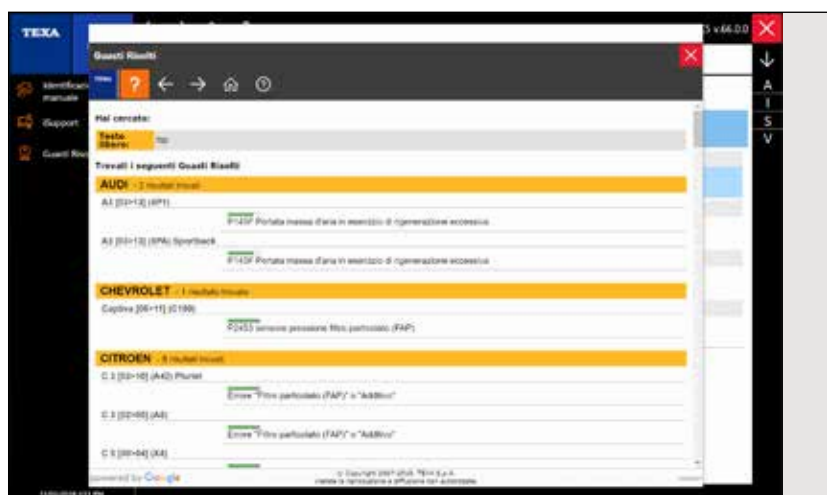

Automatic Vehicle Search

The Vehicle Search function identifies the model you are working on precisely and rapidly. Quick and intuitive, the Vehicle Search function can be used in the following ways:

VIN code search: with the diagnostic tool connected to the vehicle's OBD socket, this function automatically retrieves the VIN and then selects the model of vehicle from the IDC5 software database.

Engine number search: in this case the vehicle is identified simply by entering the engine number.

Registration number search: this function lets you find and load data for any vehicle saved in IDC5's Customer Management database, simply by entering the complete or partial registration number.



Recording of diagnostic sessions Rec & Play

A fault may occur in a vehicle under specific operating conditions only: for example, a power loss while driving uphill, when the vehicle is under a particularly high load, or a fault warning light that turns on only when the engine is warm. Under conditions like these, the Rec & Play function offers the perfect solution, as it lets you record parameter values and any errors that occur during a road test. Data can be viewed and analysed later and even printed out as a report on the test.



TGS3s global system scan

The amazing TGS3s automatically scans all the accessible* control units on the vehicle. The system is impressively fast in the way it recognises the ECUs and accesses the relevant diagnostics. On completion of the scan, TGS3s immediately displays any errors detected on the vehicle along with the relevant error codes and descriptions. It also lets you read and reset errors with a single click. You can even run autodiagnosics on selected systems directly from the error detection screen.

*TGS3s scanning may not function with older models of vehicle since previous generation control units may not support the latest scanning functionalities.

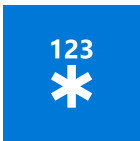

Freeze Frame

Freeze Frame lets you view the display of parameters and data detected and recorded at the moment a fault occurs. The actual information displayed by Freeze Frame may vary from one vehicle manufacturer to another and from one type of system to another.



Error Help

"Error Help" is the easiest and most accessible way to obtain information on errors. The help content provides useful information on the meaning of error messages and if necessary, on what checks to perform first.



Data sheets

TEXA's technical bulletins provide superbly accurate information on the selected vehicle, including instructions for performing a manual reset after servicing, overviews of specific mechatronic systems and much more.



Technical Specifications

An extraordinary database containing details of all vehicles. Users can find detailed and comprehensive information on Mechanical Specifications, Wheel Alignment, Tire Pressures, Timing Belt, Routine Maintenance, Component Locations, Component Testing and much more.



DASHBOARD

One of the exclusive functions available in the IDC5 operating software is the DASHBOARD*, which offers the possibility to view the vehicle's engineering parameters, associated with intuitive captivating graphics that reproduces the dashboard of an industrial vehicle, the mechanical components and the system's operating logic.



System wiring diagrams

Wiring diagrams are prepared by TEXA's own engineers. Because they follow the same standard for all vehicle manufacturers, they are a great help in troubleshooting. While you are consulting a wiring diagram, you can also access related datasheets by selecting a specific component or use the SIV function to perform oscilloscope tests using automatically selected settings.



Wiring Diagram Detail

This function makes an instant link between the error read from the control unit and the corresponding component on the wiring diagram. From the wiring diagram you can access the test functions and device descriptions typical of the IDC5 operating environment.



PASS-THRU**

This function lets you connect to the central server of any vehicle manufacturer and download software packages or official technical information

*The DASHBOARD function is already available and activated for customers who use the AXONE NEMO 2 diagnostic tool. For customers who use other diagnostic solutions instead, the function can be purchased through a dedicated "APP" within the "TEXA APP" virtual store.

**At the website www.texa.com/passthru, verify the recommended minimum hardware requirements and the enabled vehicle manufacturer diagnostic functions.

Diagnostic solutions

TEXA's diagnostic solutions are based on the powerful **AXONE NEMO 2** display unit and on the robust **NAVIGATOR TXTs** and **Navigator NANO S** vehicle interfaces. These devices connect and communicate with the vehicle's electronic control units and guarantee levels of speed and performance that are simply unrivalled in the world of multi-brand diagnostics.

TEXA devices provide unique support for today's vehicle technicians and also stand out for their ease of use and versatility. All TEXA interfaces are fully compatible with standard personal computers.

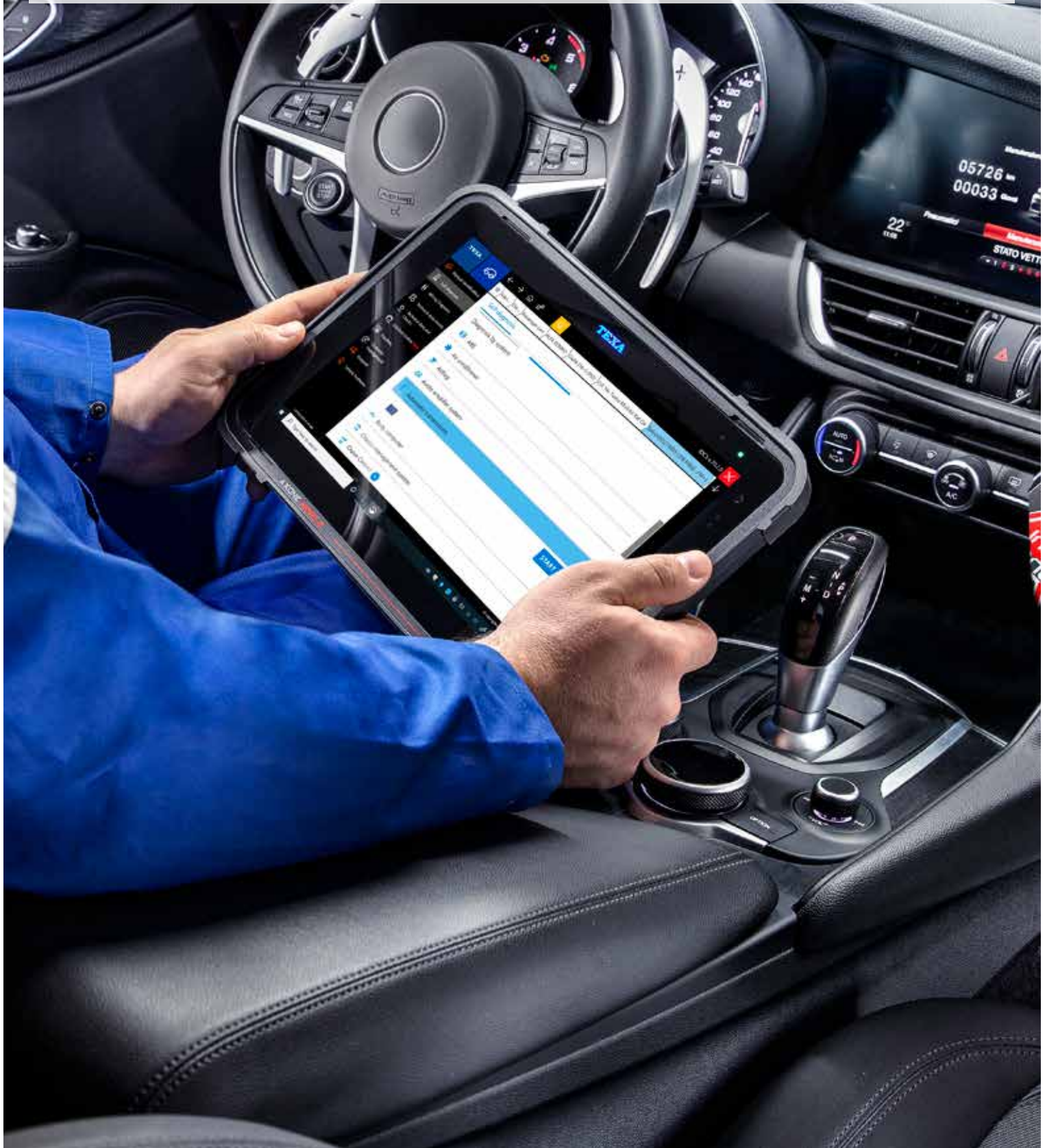

AXONE NEMO 2

AXONE NEMO 2 is the top-of-the-range multi-brand display unit. Being a multi-environment tool, it guarantees that mechanics can carry out quick, complete and precise operations on **cars, light commercial vehicles, trucks, agricultural and construction vehicles, bikes** and **boats**. It has a **12-inch capacitive** screen, with 2160x1440 resolution, protected by Gorilla Glass. Inside, the Windows 10 Enterprise operating system is powered by an Intel® Pentium Quad Core N5000 processor with 8 GB DDR4 RAM and 250 GB PCIe SSD storage. Connectivity is guaranteed by an advanced dual-channel **Wi-Fi** system and a **Bluetooth® 4.2** module. Another distinctive element is the **military standard MIL-STD 810G** (transit drop test), which makes the tool resistant to impacts and falls.





NAVIGATOR TXTs

The NAVIGATOR TXTs is the most powerful, highest performer of TEXA's vehicle interfaces and lets you work in the **CAR, TRUCK, BIKE, OFF-HIGHWAY and MARINE** environments.

You can use it to run autodiagnostic tests, view parameters, status, activate devices, perform adjustments and configurations, reset warning lights, maintenance, service and airbag indicators, configure ECUs, program keys and remotes and much more.

The NAVIGATOR TXTs is **compatible with PASS-THRU protocol***, which allows workshops to connect to manufacturers' central servers and download software packages or official technical information.



*At the website www.texa.com/passthru, verify the recommended minimum hardware requirements and the enabled vehicle manufacturer diagnostic functions.

Navigator NANO S

The Navigator NANO S is the simplest of TEXA's vehicle interfaces.

Small, **lightweight and ergonomic** and extremely quick in exchanging data both with the vehicle and the diagnostic display unit, this vehicle interface allows you to carry out all operations on cars, light commercial vehicles, motorcycles, scooters, quads and jetskis.

Every aspect of the Navigator NANO S has been carefully designed and developed to fully satisfy the needs of the modern workshop and to allow technicians to complete all **diagnostic tests quickly and easily**.



DoIP NODE

DoIP NODE is the multi-brand adapter developed by TEXA, which allows carrying out high-speed **DoIP (Diagnosis Over Internet Protocol) diagnostic** operations on vehicles equipped with an **Ethernet communication BUS**, a new architecture that manufacturers are beginning to implement along with the traditional CAN-BUS line. The use of the DoIP NODE represents a great advantage for mechanics, as they **do not have to replace the TEXA instrumentation they already own**, but simply integrate its operation using it when the vehicle they are working on requires it.

Its **reduced dimensions** (70 mm x 120 mm x 40 mm) allow inserting it between the traditional OBD socket and Navigator NANO S interface and each time it identifies which protocol the vehicle uses.



TPMS solutions

European legislation requires that all vehicles destined for the transport of passengers must be equipped as standard with TPMS (Tire Pressure Monitoring System). TEXA offers four different solutions for repairing tire pressure monitoring system malfunctions, resetting dashboard warning lights and performing other tire-related tasks in modern tire fitting centres.



TPS2

This tool has been **specifically designed for tire specialists** and for a complete, professional use with vehicle TPMS systems. Its most salient characteristics include robustness, speed and user-friendliness thanks to its **simple and intuitive graphic interface**. The TPS2 boasts a generous, high resolution colour display that makes reading data and using the tool easy even in bright sunlight.

TPS2 has an **8 GB internal memory** to store and recall the reports of the operations carried out on customer vehicles at any time, but also to manage the seasonal tire change efficiently.

The tool includes a software utility that is very useful to activate it, access the manuals, search for updates and launch the **TEXA TIRE MANAGER** software for managing tires.



SMART headlight

eLight is the most **advanced headlight** alignment system on the market today, and the first **with integrated electronic diagnostics**. eLight's digital electronics use a built-in camera, a system of algorithms and integrated autodiagnosics to identify the type of headlight and to guarantee maximum precision of alignment. eLight can even produce a detailed report, based on digital analysis, for attachment to the garage worksheet, and is already fully compatible with the legislation governing PTI centres.

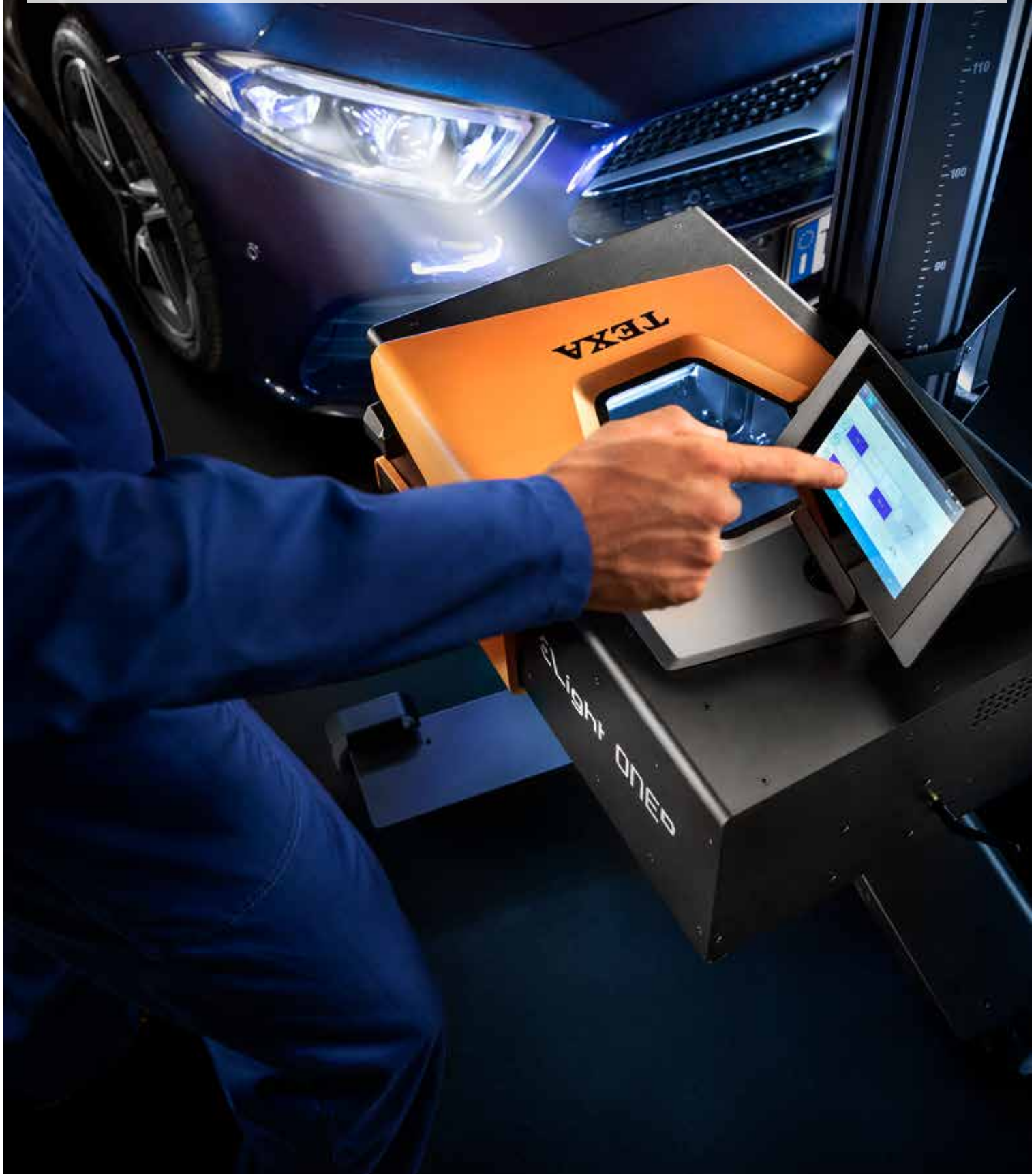

eLight

TEXA eLight comes in **two versions, ONE** and **ONE^D**.

Version **ONE** of eLight is designed to work with the **AXONE NEMO 2** diagnostic tool and a TEXA Navigator interface, and adds headlight alignment functionality for garages who already own these tools.

You can use IDC5 software to extend the potential of your eLight and to dialogue with the control units of all the electronic systems connected to the headlights in order to identify errors, read parameters and change **settings** as necessary. In practice, eLight's integrated autodiagnostic functionalities are added to those of your existing TEXA diagnostic tool.

Version **ONE^D** differs in having its own **display** based on a bright **7 inch swivelling TFT touch screen**. This version can therefore serve as a stand alone tool, using its own built-in diagnostics.

To extend functionality even further, however, **ONE^D can also be connected to an existing TEXA diagnostic tool** for use as part of an integrated system.



eLight ONE



eLight ONE^D

RCCS 3

two versions for a top-of-the-range solution

The unit, designed and engineered by TEXA, is available in two versions: **RCCS 3 with Monitor** and **RCCS 3 with Panels**.

TEXA's solutions guarantee vast handling possibilities through a simple, quick, precise adjustment and can be used both with the **toe and thrust axis check kit** and in the **optical alignment mode**.

Two versions, two ways to approach work, but a unique result: **maximum safety for drivers and for who performs the calibrations**, made possible by the high practicality and precision of RCCS 3.



RCCS 3 with Monitor

the digital innovation for calibrating ADAS

RCCS 3 with Monitor is equipped with a **75-inch HD screen, 4K definition**, which always offers an optimal display, meeting the 1:1 proportion ratio in line with the specifications of every manufacturer. Furthermore, it is important to highlight that it does **not deform nor resize** the images.

Thanks to a built-in Mini PC, RCCS 3 synchronises perfectly with the IDC5 software: the panels are selected and set on the monitor without any possibility of error. Thanks to continuous **software updates** that each time offer new vehicles and eventually new panels, and to the essential **help sheets** edited per make and model, users are sure to complete any operation with maximum precision and to the highest standards, relying on an extraordinary coverage.



RCCS 3 with Panels

the version with physical targets

As already mentioned, RCCS 3 can also be purchased in an "entry level" configuration that has the same exclusive features of the top-of-the-range version but requires using physical panels in place of the monitor.

This allows using the TEXA panels and accessories dedicated to calibration to complete any operation with maximum customer satisfaction.



Precise, simple and quick adjustments and movements

RCCS 3 is made up by a very robust main support, which height can be adjusted thanks to its electrical operation. Using practical knobs, **it can be easily tilted to the side and forward**.

A handwheel and a laser level allow also performing millimetric side movements. On top of the unit there is another laser level, very useful for finding the centre of the vehicle simply pointing it onto the front logo.

The horizontal adjustment bar is equipped with two distance measurers and a reflecting plate, the latter with a central laser for the front radar's aiming.

RCCS 3 is easy to move within the workshop thanks to its **oversized pivoting wheels**.

This technological equipment allows positioning RCCS 3 and aligning it correctly with respect to the vehicle and to the ground **easily**, with **absolute precision** and in complete **safety**.

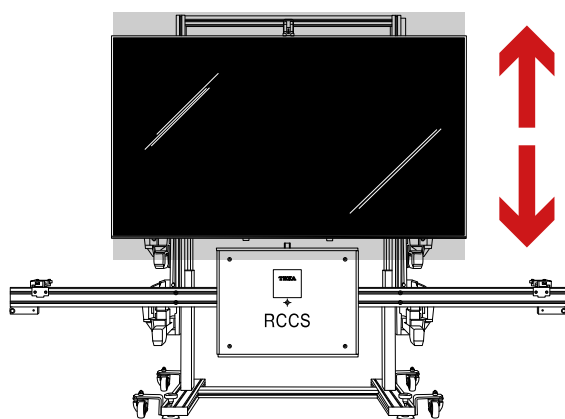

Upward moving

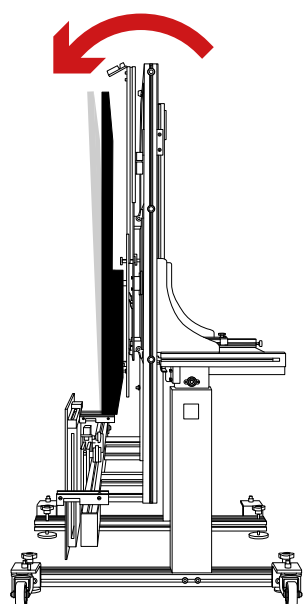
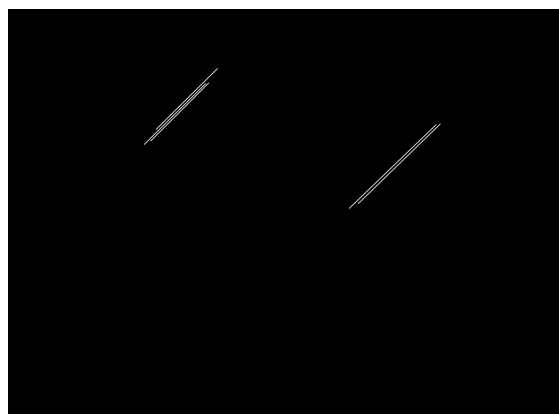

Forward tilting
only in the version with Monitor

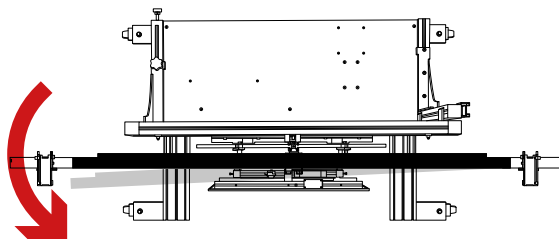

Side tilting



An ad-hoc solution for wheel alignment and toe

Before any calibration, other than verifying the alignment of RCCS 3 with respect to the vehicle, it is important to also check the **ride height of the vehicle** you are working on.

These operations are possible thanks to the use of **four CCD electronic detectors** (to be installed on the wheels, using the rim-clamping system, and on the sides of the horizontal adjustment bar) and to the accuracy of the **TOE AND THRUST ANGLE CHECK** software application.



Very performing even with the optical alignment

Other than the version with toe and thrust axis check, RCCS 3 is also available in the **highly performing optical alignment** mode. This configuration uses **wheel clamps** and was designed to complete all the operations on radars and cameras in a quick and precise way.

In order to align the vehicle, two practical aiming bands are used, onto which the lasers of the two distance measurers on the unit's main axis are addressed.



A large range of accessories for a complete solution

TEXA's ADAS solutions can be used in combination with other optional devices to work in depth on other electronic driver assistance systems, among which:

ACS (All-Around Calibration System)

ACS allows **calibrating 360° cameras and Dopplers*** for **VAG Group** (AUDI, SEAT, SKODA, VOLKSWAGEN, LAMBORGHINI) vehicles.

It is made up by an aluminium structure that has two horizontal panels and two vertical magnetic boards. The base has three housings for three distance measurers dedicated to verifying the correct alignment with respect to the vehicle.

TEXA's solution is featured by a **great practicality** being equipped with wheels that allow moving quickly within the workshop.

IR Calibration Target and Night Vision System

They are two very useful accessories as they allow **calibrating the infrared camera**, in a short time and with maximum precision, for the **Mercedes** and **VAG Group** vehicles in which it is installed. It is an essential device from the point of view of road safety, which helps drivers detect in advance people or animals in the dark. Positioned in front of the vehicle, the IR Calibration Target and Night Vision System **simulate the presence of a warm body**.

Blind spot radar reflector

It is an essential device for calibrating the ultrasonic radars installed in vehicles of the makes **HYUNDAI, HONDA, KIA, LEXUS, MAZDA, MITSUBISHI, SUBARU, TOYOTA**. It is made up by a metal reflector cone, a laser and a goniometer jig to help the technician position the pyramid cone correctly. It can be used both for the **front radars** and for the **side** and **rear** radars.

Doppler Simulator

This accessory also is needed to calibrate the blind spot radar. However, in this case it is an active simulator that responds to the frequency generated by the rear radar in **MAZDA** and **VAG Group** vehicles.

360° mats for TOYOTA, LEXUS, SCION and SUZUKI

A modular kit that allows calibrating the 360° vision system in **TOYOTA, LEXUS, SCION** and **SUZUKI** vehicles equipped with this technology.

Tire tread depth and brake disc wear measurement

Driving safety and comfort are factors that are increasingly important and crucial for drivers. In this context, one of the tests that must be carried out periodically is the one related to the conditions of the wheel system. Using TEXA's profilometer, the LASER EXAMINER, is essential as it allows measuring the brake disc wear and tread depth quickly and with precision and professionalism.



LASER EXAMINER

LASER EXAMINER is a practical, small-sized **laser caliper** that allows you to measure the vehicle **brake disc wear** with an accuracy of one-tenth of a mm, without having to remove the wheel. Other than this measurement, using a simple adapter you can also check the **tire tread wear**. LASER EXAMINER carries out both verifications quickly and easily; it allows you to provide customers with an accurate report on the "state of health" of their vehicle wheels, ensuring a professional assistance service and fostering customer loyalty.

LASER EXAMINER is a real added value for workshops and tire specialists, and at the same time it is an important contribution to the **safety of vehicles** on the road.

For an optimal check and management of the measurements on discs and tires, TEXA has developed a practical software program to be installed on AXONE NEMO 2 or PC and to be used in combination with LASER EXAMINER. Thanks to a simple and intuitive graphic interface, an **objective test of the "wheel system"** can be completed in next to no time.



Electrical diagnostics

In many cases, autodiagnosics cannot provide the answer. If a vehicle's ECUs have no errors logged, the problem may well lie in an electrical or mechanical failure. Conventional diagnostics are needed in these circumstances and analog and digital measurements are taken to determine the efficiency of components like the battery, sensors, actuators and CAN network. TEXA's UNIProbe and TwinProbe interfaces let you make all the physical measurements you need to perform a conventional diagnosis and identify potential faults.



UNIProbe

The UNIProbe includes:

- **Oscilloscope:**

four independent analogue channels, complete with SIV* function for interpreting measured signals.

- **Battery Probe:**

for testing the battery, analysing and checking the entire starting and charging system.

- **TNET:**

for the measurement and electrical analysis of CAN automotive communication networks.

- **Signal Generator:**

for simulating the pulses generated by sensors and the commands generated by control units and testing solenoid valves and other components.

- **Multimeter:**

for voltage, resistance and current measurements (using a clamp-on ammeter).

- **Pressure Tester:**

for checking fuel supply and turbocharger pressure on all vehicles.



TwinProbe

The TwinProbe includes:

- **Oscilloscope:**

two independent analogue channels with inputs up to $\pm 200V$, complete with SIV* function for interpreting measured signals.

- **Signal Generator:**

for simulating the pulses generated by sensors and the commands generated by control units and testing solenoid valves and other components.



*Indication of the range of values that the working component should measure.

KONFORT A/C RECHARGE STATIONS for R1234yf, R134a and R744 (CO₂)

The KONFORT 700 range includes 11 models with different specifications and operating modes, for servicing vehicle air conditioning systems containing R1234yf, R134a or CO₂.

The range is produced on an assembly line that is the only one of its kind in the world to ensure the ultimate in quality and lasting reliability. The KONFORT range features a total of 10 registered international patents. The components used all have exceptional characteristics and guarantee refrigerant recovery efficiency in excess of 95%. The neat design combines easy handling, sturdiness and safety to make all maintenance operations simple and easy.



THE KONFORT RANGE IS APPROVED BY:

AUDI	JAGUAR	MINI	SEAT
BENTLEY	KIA	MITSUBISHI	SKODA
BMW	LAMBORGHINI	NISSAN	SUBARU
BUGATTI	LAND ROVER	OPEL	SUZUKI
CHEVROLET	MAZDA	PORSCHE	TOYOTA
HYUNDAI	MERCEDES-BENZ	RENAULT	VOLKSWAGEN



Check with your TEKA Distributor the model and type of refrigerant recommended from each individual car marker listed.

A/C KONFORT for CO₂

744

The KONFORT 744 is designed and made to work with the latest A/C systems containing **CO₂**.

The service station is fully automatic and capable of completing the entire service procedure without input from the operator. It also achieves the **highest possible levels of precision**. In fact, the quality of its components and the accuracy of its design permit recharging to be completed to a maximum tolerance of only 10 grams (2 grams for oil).

Special attention has also been paid to the system for releasing CO₂ into the atmosphere. This takes place in a controlled manner to ensure the safety of the operator and of the system itself.

The KONFORT 744 also incorporates an accurate system for **measuring the concentration of CO₂** in the surrounding air, and suspends charging if this approaches a dangerous level.





A/C KONFORT for R1234yf

707R

This new A/C recharge station works with R1234yf refrigerant. Essential and simple to operate, it nevertheless incorporates all the latest design solutions. It is fully automatic and guarantees excellent efficiency and safety.

Compared to the competition, this recharge station stands out for its advanced features: the **filter dryer** that lets you perform approx 300 system services; **scales locking system**; alphanumeric keyboard; 4 castors; and a **maintenance log with data on all services completed**.

770S

TEXA developed the KONFORT 770S to meet the **rigorous specifications of German vehicle manufacturers**. This model works only with the new **R1234yf refrigerant**. It has been homologated by **TÜV Rheinland**, the leading international certification body.

The 770S is equipped as standard with a **Refrigerant Identifier Kit**, an exceptional device capable of recognising what type of gas is contained in an A/C system.

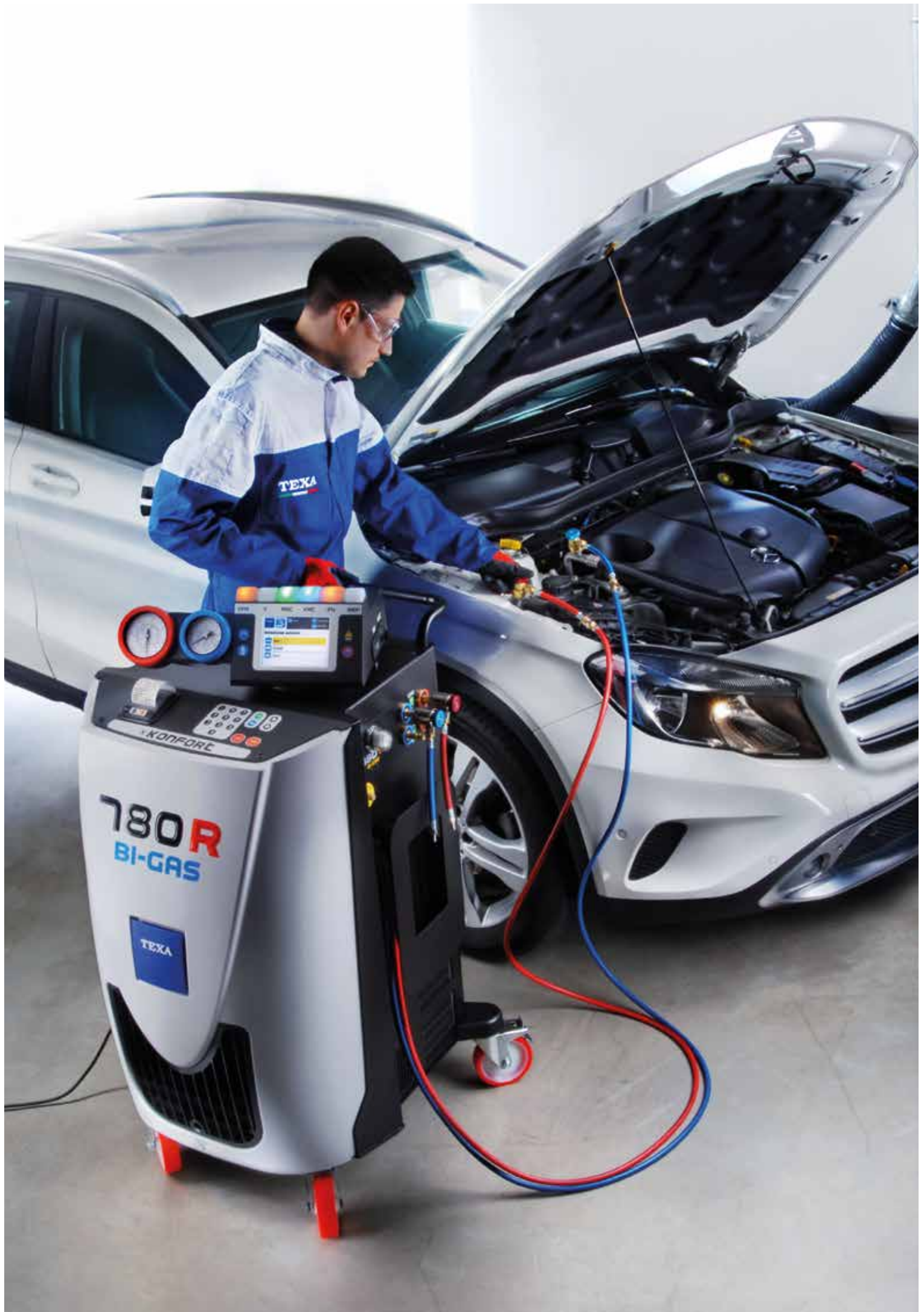

A/C KONFORTfor R1234yf and/or R134a

712R

KONFORT 712R is TEXA's new mid-range A/C charging station which boasts the typical technical features of the top-range models such as the **automatic maintenance service management** and the **measuring of the amount of oil recovered with the electronic scale**. The KONFORT 712R can be purchased in the **R134a** or **R1234yf** version with the option to change the configuration.

Other distinctive features of the KONFORT 712R compared to the other models in its category, is the **possibility to install the Refrigerant Identifier Kit** and to use it in combination with REC+, the innovative device patented by TEXA for the recovery of contaminated refrigerants from the vehicle A/C systems.

KONFORT 712R is the ideal solution because with a **limited investment** the mechanic can have a station with exclusive features and top class performance, ensuring customers a **high level of service** over time.



720R

This model can service all car, commercial, truck and off highway A/C systems but comes at a highly competitive price. It features **automatic refrigerant recovery** and recycling and oil drain functions. Oil and UV tracer volumes are monitored by an automatic system, leaving you to perform only a few simple manual operations. The 720R can be delivered preconfigured for the old R134a or the new R1234yf refrigerant.

760R and 760R BUS

The 760R incorporates TEXA's most advanced technology: it is equipped with **hermetically sealed oil/UV bottles**, a fully automatic maintenance management system, scale locking device and **automatic** verification of correct refrigerant weight. The KONFORT 760R can be pre-configured for use with either R134a or R1234yf. One of the most interesting optionals for this model is the Refrigerant Identifier Kit.

The 760R is also available as the 760R BUS, for use with larger vehicle A/C systems.

780R

This amazing recharge station is the top of the KONFORT Series and offers technicians the ultimate in performance and in the number of jobs it can handle. The KONFORT 780R **can work with both 134a and 1234yf refrigerants**, switching from one type to the other in next to no time thanks to two separate tanks and a sophisticated flushing system that effectively and **safely cleans out all the pipes**. When equipped with the Refrigerant Identifier Kit, this is the best recharge station on the market today and offers workshops the ultimate in performance.



See the catalogue for the KONFORT 700 SERIES for details of all available accessories.

A/C KONFORT for R134a

705R and 705R OFF ROAD

The KONFORT 705R is the “entry level” recharge station for air conditioning systems using with **R134a refrigerant**. Though easy to use and **attractively priced**, the KONFORT 705R can handle all common refrigerant recovery and recharging operations. It is the ideal solution for workshops that need to offer their customers impeccable service while **keeping a close eye on operating costs**.

This model is also available in an OFF ROAD version with larger rear wheels and a metal bar for improved stability and easier use **on rough surfaces**.

710R

Though it is the entry level model, the 710R offers all the key functions of the KONFORT 700 Series, including automatic leak detection, electronic refrigerant weighing, automatic timed oil and UV tracer injection, and high efficiency refrigerant recovery.

APP KONFORT

The KONFORT range models 720R, 760R, 760R BUS, 770S and 780R BI-GAS can interface with Android and iOS mobile devices thanks to a dedicated APP.

This APP allows technicians to **follow** the vehicle A/C **system service procedures** in progress also remotely, directly from the **smartphone**. Furthermore, the new APP allows you to manage the performed maintenance services easily, even when the station is turned off.



Refrigerant Identifier

The innovative Refrigerant Identifier, developed by TEXA, is the only kit of its kind currently made in Europe. It comes as standard equipment on the KONFORT 770S and as is available as an option on all other versions (except the 705R, 705R OFF ROAD, 710R and 720R). Protected by three registered international patents, the kit **guarantees the purity of R134a and R1234yf refrigerants**, stops technicians performing operations that might prove hazardous and prevents the dangerous mixing of different refrigerant types.



Simple, quick, smart just a “touch” for recharging

Its more than ten years' leadership in the vehicle A/C service and recharge field has allowed TEXA to obtain the approval and recommendation by the major vehicle manufacturers worldwide. From the same experience, TEXA has given birth to **KONFORT TOUCH**, a range of charging stations characterised by exceptional manufacturing quality, designed for all the A/C service operations on vehicles that use refrigerant **R134a** and **R1234yf**.

In a **simple, quick, smart** way, and with the utmost ease of use.

The KONFORT TOUCH range is:

Simple, because its **10-inch colour touchscreen display**, the Android™ operating system and its main service dashboard allow users to customise the charging operations and start them really easily.

Quick, because the navigation menu enhances the user experience and gathers all the key functions in the main page, allowing users to complete the operations with absolute precision and in just a few steps.

Smart, because its advanced connectivity allows it, for example, to update automatically, receive remote assistance and connect to other devices, such as printers and smartphones. Moreover, it uses a search algorithm that identifies the vehicle in the wide database by simply entering a keyword, therefore avoiding the classic selection of make and model.

*Simple and intuitive
thanks to its wide
touchscreen display*

*Flexibility of use
with the built-in Wi-Fi*





**Even quicker
A/C service**

Four models for every need

The KONFORT TOUCH range includes four models; each of them is rich in exclusive functions and special features, for every operational need.

KONFORT 780 TOUCH BI-GAS (R134a and R1234yf)

The **top of the range**. It allows users to alternate services on vehicles equipped with refrigerants R134a and R1234yf, as it has **two tanks** and **two separate circuits for recovery, recycling and recharging**.

The service process is **automated**.

Other distinctive features: **airtight oil bottles**, **scale locking/unlocking** device, refrigerant weight accuracy check system, **automatic cleaning** device for all the hydraulic ducts.

KONFORT 760 TOUCH KONFORT 760 BUS TOUCH (R134a or R1234yf)

Both high-performing, also equipped with **airtight oil bottles**, **fully automatic** service management, scale locking/unlocking device and **refrigerant weight accuracy** check.

Moreover, the **760 BUS TOUCH** version is designed for larger systems and equipped with a larger tank, pump and compressor.

KONFORT 720 TOUCH (R134a or R1234yf)

"Entry level" version in the range, KONFORT 720 TOUCH has **automatic functions** for the refrigerant recovery and recycling and for the oil drain.

Quantities of oil and UV tracer are controlled by an **automatic valve system**. The operator therefore only has a few simple tasks to carry out.

A large display for great results

The KONFORT TOUCH charging stations are equipped with a **10-inch colour multi-touch screen display**, which gives them great usability and allows always having a clear view of the operations to perform. Moreover, the **innovative graphic interface** has been developed to ensure a really intuitive software user experience, making it easier to **quickly read the data** displayed.



Data reading is best supported by the high resolution and 400 nits brightness.

An interesting feature is also the possibility for the operator to choose between a light or dark theme for the background. The display on the KONFORT TOUCH stations features the **glove-touch technology**, which ensures perfect use while wearing different types of work gloves.

**10-inch colour
industrial touchscreen display**

**Glove-touch
technology**



**Quick data
reading**

**Intuitive
graphic interface**

Emissions Diagnostics

The TEXA solution for exhaust gas analysis includes a series of tools for performing all the tests and analyses currently required by emission control legislation: GASBOX Autopower, OPABOX Autopower, GAS Mobile, MULTI PEGASO 3, RC2, RC3, RCM.





Future-proof solutions for PTI center

Exhaust gas analysis is one of the most delicate and important phases in the mandatory testing of old and new motor vehicles. In recent years, advances in technology have led to the development of vehicles that are far more efficient in terms of exhaust gas emissions. Even these vehicles, however, need to be tested and certified to ensure that their emissions remain within the limits established by law. As time passes, emission limits are also becoming stricter, requiring the use of advanced technology to carry out the necessary tests. The demand for exhaust gas analysis tools is therefore constantly growing, not only from authorised vehicle test centres but from conventional garages too. TEXA has the solutions to satisfy that demand. TEXA's innovative exhaust gas analysis products are designed for use by test centers and garages performing pre-test checks. These easy to use tools incorporate TEXA's own, patented measuring technology and ensure accurate and reliable exhaust gas analysis in conformity to the latest emission control standards. Bluetooth communication technology and TEXA's Autopower battery technology mean that these tools can be used without any awkward cables. All TEXA exhaust gas analysis tools come with a practical trolley for easy mobility around the workshop without having to lift and carry them.



GASBOX AUTOPOWER

Exhaust gas analyser

The GASBOX Autopower is an exhaust gas analyser for the measurement of CO, CO₂, O₂, HC (and optionally NO) in petrol and gas fuelled vehicles. It is homologated by the Italian Ministry of Transport for use in vehicle test centres on light and heavy vehicles.

OPABOX AUTOPOWER

Opacity meter

The OPABOX Autopower verifies the opacity of exhaust emissions from vehicles powered by diesel engines. Its sensors can measure opacity from light and heavy vehicles. OPABOX Autopower is homologated according to the latest standards.



The GASBOX and OPABOX both come with a practical trolley for easy movement around the workshop. Standard Bluetooth connectivity and the optional Power Pack (external battery pack) make it possible to use both units in a totally wireless way.

MULTI PEGASO 3 and GAS MOBILE

The MULTI PEGASO 3 is an exhaust gas analysis and control station **for conventional vehicle repair shops**. The station comprises a dedicated controller with the latest generation processor, and comes with Bluetooth and Wi-Fi communication modules.

The GAS Mobile is a lightweight and **compact portable device** featuring a high-visibility graphic LCD display used to test all types of engines, running on petrol, diesel or alternative fuels. It exploits Bluetooth wireless technology to communicate with OPABOX Autopower, GASBOX and the RC2 and RC3 engine speed and temperature gauges.



RC3, RC2 and RCM

The RC3 is a universal rev counter for use with light and heavy vehicles. It incorporates two data acquisition systems: Battery ripple and OBD cable. As an option, it can also be used with an inductive clamp or piezoelectric sensor. RC3 supports EOBD protocols: ISO 9141, KW2000, PWM, VPW, CAN BUS and the recent WWH-OBD.

The RC2 is a rev counter for cars. It comes with a Battery Ripple sensor but can also be used with an inductive clamp or piezoelectric sensor (both available as optionals).

The RCM is an exclusive motor vehicle rev counter from TEXA that uses an innovative directional antenna to measure engine speed with great accuracy. The RCM is ideal for use with fully faired motorcycles on which it is not possible to use an inductive clamp.



A training programme to be always “ahead of the game”

TEXA believes customer training to be particularly important, since adequate technical competence and the correct use of diagnostic tools are critical to the success of repair work. The teaching methods used in TEXA courses are based on an ideal mix of theory and practical elements. Practice plays a fundamental part, as it combines testing and simulations with use of the technicians own TEXA diagnostic tools, thus stimulating a more active and dynamic participation and effective learning.





P5C: USE OF TEXA SOFTWARE AND DIAGNOSIS FOR CARS

AIM: Know all the functions available in TEXA's IDC5 diagnostic software and their practical application, to carry out electronic diagnoses on vehicles correctly. Among these: Automatic vehicle search, TGS3s Global System Scan; Error, Status, Parameter, Activation, Adjustment pages; Wiring diagrams, Technical sheets, Technical data and checks, Customer management, Technical support, Solved problems, Info Connect. Practical examples of self-diagnoses will be analysed during the video lesson.

DURATION: 4 hours (available also on-line)



D11C: INSTALLATION AND CONFIGURATION PROCEDURE OF THE INSTRUMENTATION FOR PASS-THRU DIAGNOSIS

AIM: Learn to access the manufacturers' websites. During the course, the trainer will configure the VCI and PC of each participant with the settings required to access the manufacturers' websites.

The course D11C is an essential prerequisite in order to access the following editions, which are specific for each manufacturer.

DURATION: 4 hours (available also on-line)



D11.1C: DIAGNOSTIC TECHNIQUES WITH THE PASS-THRU FUNCTION ON FORD AND CITROËN-PEUGEOT

AIM: Learn the procedures to access the websites in which the manufacturers FORD, CITROËN and PEUGEOT provide the information required to repair and service their vehicles: the ordinary and extraordinary maintenance registration forms, wiring diagrams, the explanation for the fault codes, the mechanical repair manuals. Be able to sign up to the manufacturers' websites and access the documents provided. Perform practical tests on the vehicles made available, using the pass-thru software programs provided by the manufacturers for reprogramming and coding control units based on the manufacturer's requirements.

DURATION: 6 hours (available also on-line)



D11.2C: DIAGNOSTIC TECHNIQUES WITH THE PASS-THRU FUNCTION ON TOYOTA-LEXUS, KIA-HYUNDAI

AIM: Learn the procedures to access the websites in which the manufacturers TOYOTA-LEXUS, KIA-HYUNDAI provide the information required to repair and service their vehicles: the ordinary and extraordinary maintenance registration forms, wiring diagrams, the explanation for the fault codes, the mechanical repair manuals. Sign up to the manufacturers' websites and access the documents provided. Perform practical tests on the vehicles made available, using the pass-thru software programs provided by the manufacturers for reprogramming and coding control units based on the manufacturer's requirements.

DURATION: 6 hours (available also on-line)



D11.3C: DIAGNOSTIC TECHNIQUES WITH THE PASS-THRU FUNCTION ON MERCEDES - SMART

AIM: Sign up to the websites in which the manufacturers MERCEDES and SMART provide the information required to repair and service their vehicles: the ordinary and extraordinary maintenance registration forms, wiring diagrams, fault codes with explanations, the mechanical repair manuals. Configure a TEXA VCI for the pass-thru communication and perform practical tests on vehicles, using the pass-thru software programs provided by the manufacturers for reprogramming and coding control units based on the manufacturer's requirements.

DURATION: 6 hours (available also on-line)



D11.4C: MAINTENANCE AND SERVICE REPORTS COMPILATION THROUGH MANUFACTURER WEBSITES

AIM: The course shows how to sign up and solve any registration problems with the online services offered by vehicle manufacturers to service and repair their vehicles (with reference to the EU Reg. No 461/2010), through practical examples of registration to the BMW, Mercedes, VW/Audi, Mazda, Land Rover websites. You will learn to use the pass-thru software programs made available by manufacturers to perform the operations required by manufacturers themselves, and to configure a TEXA VCI for the pass-thru communication to perform official diagnoses. You will learn how to access FCA Technical Information and use the enabled credits that allow you to use TEXA's diagnostic tool.

DURATION: 6 hours (available also on-line)



D11.5C: DIAGNOSTIC TECHNIQUES WITH THE PASS-THRU FUNCTION ON BMW - MINI

AIM: Sign up to the websites in which the manufacturers BMW and MINI provide the information required to repair and service their vehicles: the ordinary and extraordinary maintenance registration forms, wiring diagrams, fault codes with explanations, the mechanical repair manuals. Configure a TEXA VCI for the pass-thru communication and perform practical tests on vehicles, using the pass-thru software programs provided by the manufacturers for reprogramming and coding control units based on the manufacturer's requirements.

DURATION: 6 hours (available also on-line)



D11.6C: DIAGNOSTIC TECHNIQUES WITH THE PASS-THRU FUNCTION ON RENAULT - DACIA AND SECURE GATEWAY UNLOCK

AIM: Learn to perform the procedure to unlock the Secure Gateway installed on latest-generation Renault vehicles. Without this unlocking procedure, the normal diagnosis, including the service resets, will not be possible. Use the pass-thru software to code the control units, and especially reprogram them, updating the software or writing new control units. Learn how to use Renault's website Dialogys for independent vehicle repairers and retrieve wiring diagrams, technical manuals, fault codes with explanations, technical bulletins, repair times and spare parts.

DURATION: 6 hours (available also on-line)



D11.7C: DIAGNOSTIC TECHNIQUES WITH THE PASS-THRU FUNCTION ON FCA

AIM: Participants will be able to use the websites where the manufacturers FIAT - ALFA - LANCIA - ABARTH - CHRYSLER - JEEP and DODGE provide the information required to repair and service their vehicles. At the end of the course, participants will be able to access these websites with their own accounts and download technical manuals and repair information in general (wiring diagrams, technical bulletins, diagnostic sheets, etc.). Moreover, the participant's PC will be configured to access the manufacturer's Pass-Thru website in order to use the diagnostic procedures made available: programmings, updates, and diagnostic data reading.

DURATION: 6 hours (available also on-line)



D12C: CHECKING ACTUATORS AND SENSORS WITH SELF-DIAGNOSIS AND OSCILLOSCOPE ON MODERN EURO 6 ENGINES

AIM: Learn how to check the operation of electrical and electronic components in modern Euro 6 Diesel engines through self-diagnosis and the analysis of reference parameters. Be able to analyse the operation of components using the oscilloscope. Know the features of modern Euro 6 engines and their operating strategies. Learn how to operate on the vehicle by checking the sensors and actuators using the diagnostic tool and the oscilloscope. Be able to analyse the most common faults on modern vehicles. Know the new features of TEXA's multi-brand diagnosis and the operation of data protection systems (firewalls) used by many manufacturers on the most recent vehicles. The course is supported by practical tests and videos showing the tests carried out at the workshop.

DURATION: 6 hours (available also on-line)



D9C: ADVANCED DIAGNOSIS AND CALIBRATION OF THE DRIVER ASSISTANCE SYSTEMS

AIM: Learn the technical features and the operating modes of the advanced driver assistance systems and the operating modes, position and functions of the technologies involved: RADAR, LIDAR, camera, infrared camera, ultrasonic sensors. Know the operating principle of the following systems: Park Assist, Lane Departure Warning, Adaptive Cruise Control, Forward Collision Warning, Adaptive High Beam Control, Pedestrian Detector, Blind Spot Detection, Park Assist, Night Vision, Drowsiness Detection System. Be able to carry out diagnostic and troubleshooting procedures using the diagnostic tool, and to interpret the errors, parameters, statuses, activations and adjustments pages.

DURATION: 8 hours (available also on-line)



G1: BASIC AUTOMOTIVE ELECTRONICS AND ELECTRICAL ENGINEERING

MOD. 1-2 MOD. 3-4

AIM: Learn how to use the multimeter properly, avoiding the most common measurement errors. Be able to check the efficiency of a lead-acid, AGM, GEL and lithium battery, as well as ground points. Know the functioning and operating modes of the oscilloscope. Learn how to use the oscilloscope properly, and the basic principles to carry out checks such as: checking the smart alternator and the high and low power supplies; checking the operation of diodes and transistors in electric motors; assessing the PWM and PFM control signals of the most common electric actuators (EGR, motorised throttle, LED headlights).

DURATION: 16 hours (available also on-line)



PES-PAV QUALIFICATION: PROCEDURES TO OPERATE SAFELY ON HYBRID AND ELECTRIC VEHICLES (CEI STANDARD 11-27)

AIM: Obtain the qualification needed to perform work involving electrical risks on electric or hybrid vehicles according to CEI EN 11-27 standard, in compliance with the requirements of Legislative Decree 81/2008 governing the safety of workers. Such qualification can be given to employees only by the employer, in writing, based on professionalism, aptitude and experience. The topics covered in the online course refer to the qualification levels as per CEI standard 11-27: 1A, 2A, 1B and 2B.

DURATION: 16 hours (available also on-line)

TEXA

Founded in Italy in 1992, TEXA is today a world leader in the design, industrialisation and production of multi-brand diagnostic tools, exhaust gas analysers, air conditioning charging stations and telediagnostic devices, for cars, bikes, trucks, boats, and agricultural vehicles. TEXA is present all over the world with a widespread net of distributors: it commercialises directly in Brazil, France, the UK, Germany, Japan, Spain, the US, Poland and Russia through its subsidiaries. TEXA currently employs some 700 people around the world, including over 150 engineers and specialists working in Research and Development. Over the years, TEXA has received a large number of prizes and awards for innovation, in many countries worldwide. All TEXA tools are designed, engineered and built in Italy, using extremely modern automated production lines which guarantee maximum precision. TEXA is particularly committed to the quality of its products: it obtained the strictest certifications, such as the TISAX (Trusted Information Security Assessment Exchange), a standard defined by the VDA, the German Association of the Automotive Industry, which guarantees the highest level possible of information and know-how protection against increasingly frequent cyber-attacks. It joins other certifications, such as the IATF 16969, specific for first automotive suppliers; the VDA 6.3, another method by German manufacturers that established itself as an international point of reference; and the ISO/IEC 27001 in the information security field.

WARNING

The trademarks and logos of vehicle manufacturers in this document have been used exclusively for information purposes and are used to clarify the compatibility of TEXA products with the models of vehicles identified by the trademarks and logos. Because TEXA products and software are subject to continuous developments and updates, upon reading this document they may not be able to carry out the DIAGNOSTICS of all the models and electronic systems of each vehicle manufacturer mentioned within this document. References to the makes, models and electronic systems within this document must therefore be considered purely indicative and TEXA recommends to always check the list of the "Systems that can be diagnosed" of the product and/or software at TEXA authorised retailers before any purchase. **The images and the vehicle outlines within this document have been included for the sole purpose of making it easier to identify the vehicle category (car, truck, motorbike, etc.) for which the TEXA product and/or software is intended.** The data, descriptions and illustrations may change compared to those described in this document. TEXA S.p.A. reserves the right to make changes to its products without prior notice.



To check out the extensive coverage of TEXA products, go to:
www.texa.com/coverage

To check on IDC5 compatibility and minimum system requirements, go to:
www.texa.com/system

The Bluetooth® brand is the property of Bluetooth SIG, Inc., U.S.A., and is used by TEXA S.p.A. under license.
Android is a trademark of Google Inc



facebook.com/texacom



linkedin.com/company/texa



instagram.com/texacom



youtube.com/texacom

Copyright TEXA S.p.A.
cod. 8801785

08/2021 - Inglese - V17



TEXA

TEXA S.p.A.

Via 1 Maggio, 9
31050 Monastier di Treviso
Treviso - ITALY
Tel. +39 0422 791311
Fax +39 0422 791300
www.texa.com - info.it@texa.com

COMPANY WITH
QUALITY SYSTEM
CERTIFIED BY DNV GL
= ISO 9001 =